

PERIBEST I43 DATASHEET

TECHNICAL SPECIFICATIONS	MODEL I43
Max. Flow (continuous)	7000 l/h
Capacity	1,69 l/rev
Max. Discharge Pressure	10 bar
Max. Temperature	80 °C
Inner Diameter	43 mm.
Hose material	NR, EPDM and NBR (Food Grade)
Connections material	AISI-316, PP, PVDF (PTFE)
Pump casing material	Cast Iron (powder coated)
Rollers material	Hard aluminium (Anodized)

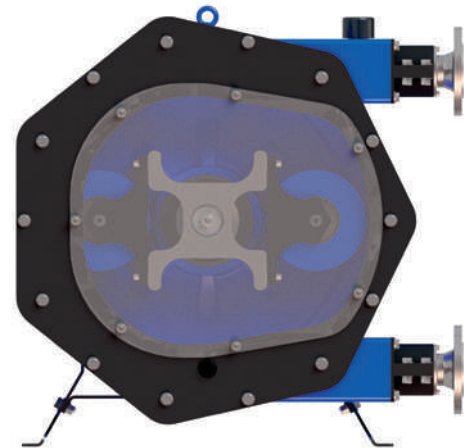

MAIN FEATURES AND BENEFITS

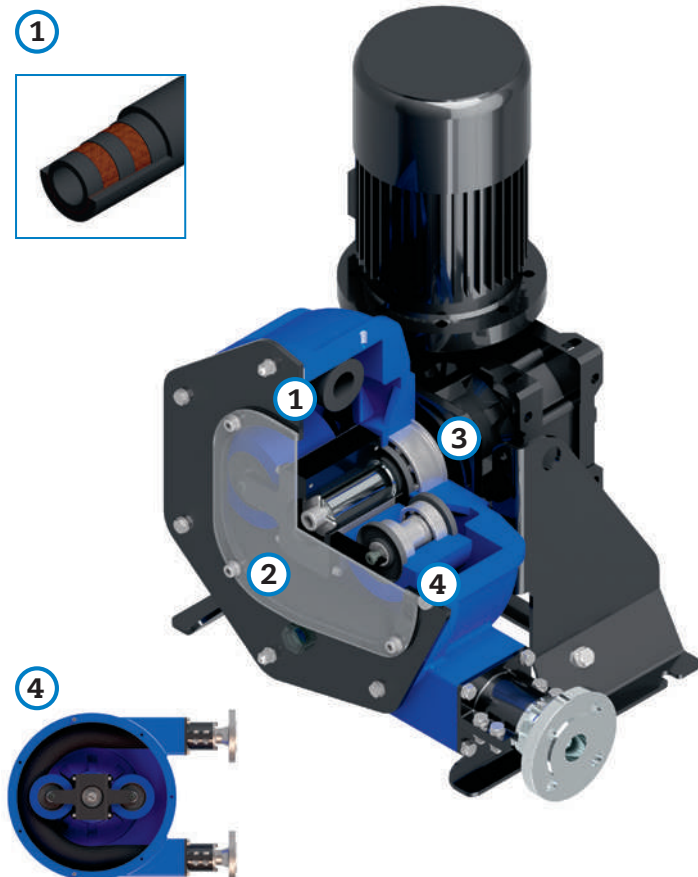

1 LATEST TECHNOLOGY PERISTALTIC HOSE.

SAVING ON HOSE CONSUMPTION AND EASE OF INSTALLATION DOWNTIME OPTIMISATION.

2 EASE OF ASSEMBLY, OPERATION AND MAINTENANCE.

SAVING ON MAINTENANCE COSTS AND EASE OF ASSEMBLY. LESS DOWNTIME.

3 EXTREMELY HEAVY DUTY DESIGN FOR THE MOST DEMANDING APPLICATIONS UP TO 10 BAR.

UNMATCHED PUMP LIFE AND EXCELLENT EQUIPMENT PERFORMANCE UNDER ANY OPERATING CONDITIONS HOWEVER DEMANDING.

4 XXL ROLLER TECHNOLOGY.

MAJOR ENERGY SAVINGS, HIGHER NUMBER OF HOSE WORKING HOURS AND EASE OF OPERATION.

**REQUIRED
MOTOR POWER (KW)**

**PRODUCT
TEMPERATURE (°C)**

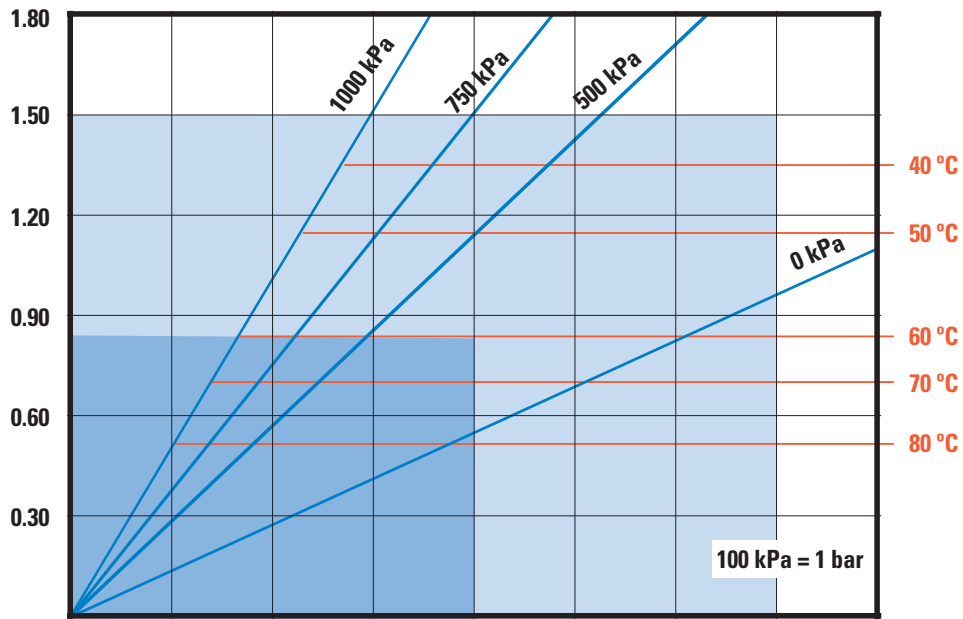

PUMP SPEED (RPM)	10	20	30	40	50	60	70	80
CAPACITY (L/H)	1015	2030	3045	4060	5075	6090	7105	8120

PRESSURE (kPa)	0 kPa	500 kPa	750 kPa	1000 kPa
TORQUE (Nm)	125	275	355	475

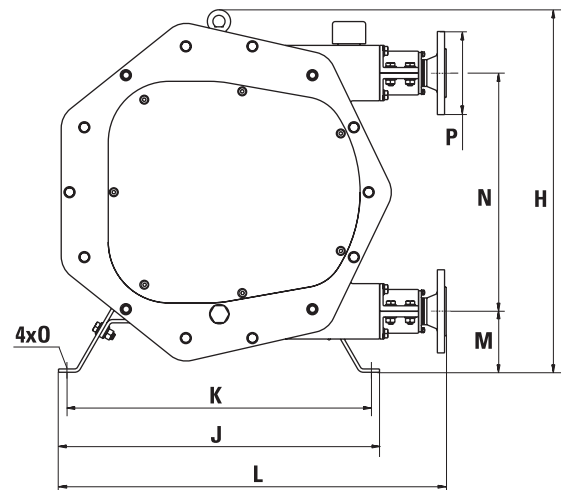
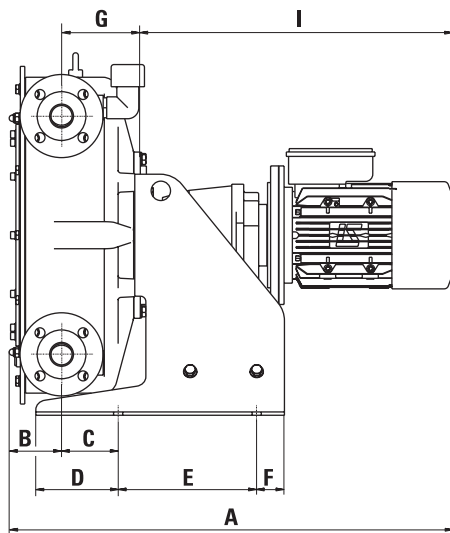

MODEL	A*	B	C	D	E	F	G	H	I*	J	K	L	M	N	O	P
I43	800,6	96,6	102	148,5	250	50	142	655	564	580	550	700	110	430	16	DN-40

*Depending on the driver, dimensions could change.